

REV	EAC NO.	DESCRIPTION

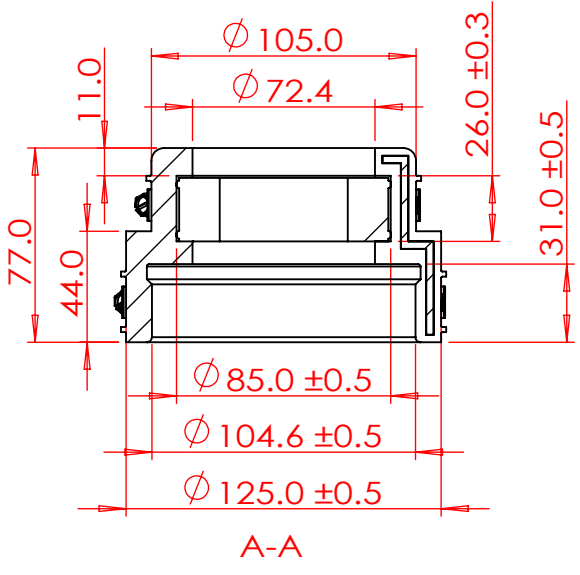
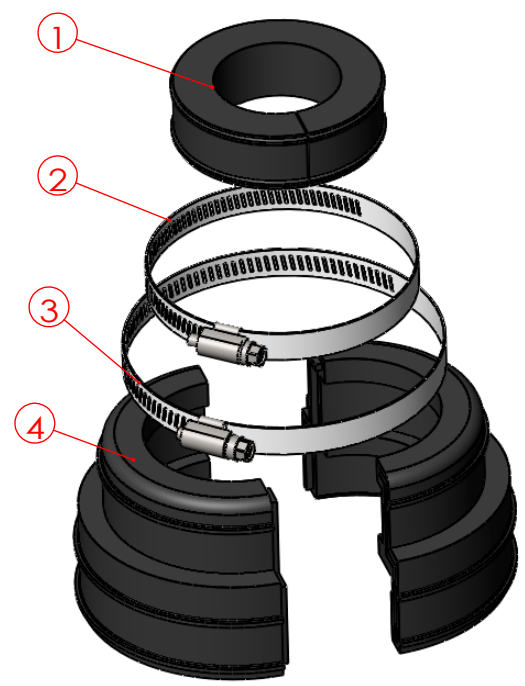
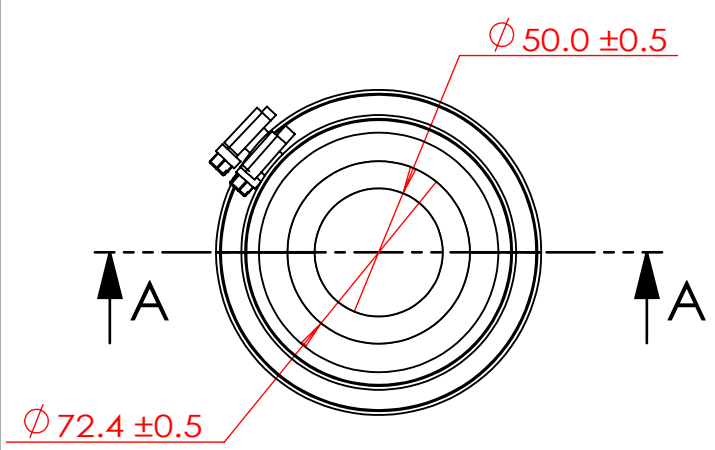

RELEASE LEVEL:
FILE NAME:

MAXDAO

江苏迈道通信科技有限公司

TITLE:
4" boot, 1 run 1-5/8" cable boot assembly

MAXDAO LIMITED RESERVES THE RIGHT TO CHANGE SPECIFICATION OR CONFIGURATION WITHOUT PRIOR NOTIFICATION. THESE DRAWINGS AND SPECIFICATIONS ARE THE PROPERTY OF MAXDAO LIMITED AND SHOULD NOT BE REPRODUCED OR COPIED WITHOUT WRITTEN PERMISSION.

DRAW:	XUDEYA	DATE:	2017-02-26
CHKD:		DATE:	
VRFD:		DATE:	
APPD:		DATE:	
PRODUCT:			

UNITS:	mm	DWG NO.:	10001189	DWG VER:	A
FINISH:		ITEM NO.:		ITEM REV:	
MASS(Kg):	1.6	SCALE:	1:2	MAT'L:	
SHEET:	1 OF 1				